



# ReBAR™

SUPPORT PRODUCTS



800-326-8554

Simply the best,  
strongest grade  
chair with base in  
the industry.

# PCGCB

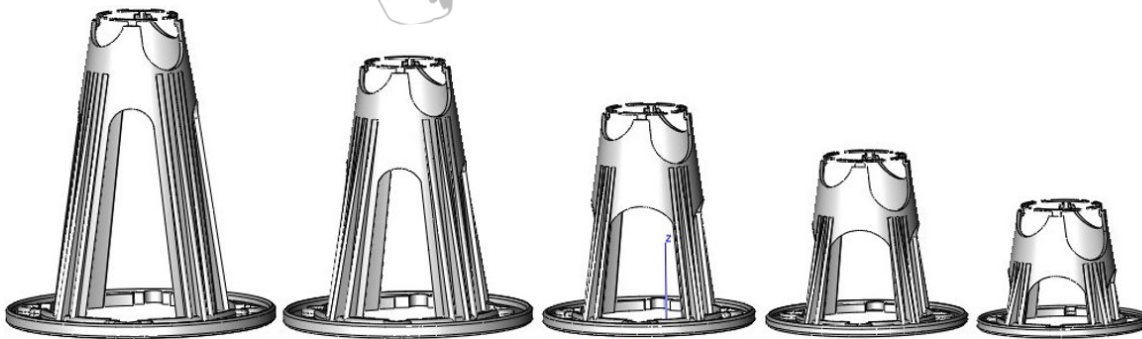

ITEM	HEIGHT	MAX BAR	PCS/BOX	BOXES/PALLET
PCGCB200	1.5"-2"	#8	100	55
PCGCB300	2.5"-3"	#8	100	36
PCGCB400	3.5"-4"	#8	100	24
PCGCB500	4.5"-5"	#8	100	28
PCGCB600	5.5"-6"	#8	100	20

## Grade Chair With Base

- Primary use is for slab on grade use.
- Each chair can be used for 2 different height applications.
- Manufactured from Polymeric Carbon ABS Plastic
- Works well with up to #8 rebar
- Internal testing: minimum failure 947 pound, maximum failure 1,280 pounds
- Meets or exceeds requirements of CRSI Class 1 Bar Support
- Plastic tangs on the top help secure if used with wire-mesh, break away when used with rebar.

[www.rebarsupportproducts.com](http://www.rebarsupportproducts.com)